



FOOD
COLLECTION



PRESERVED MEAT & FISH

Simple, transparent – let the product speak for itself.



155ML TERR LG 100GR TO82

AVAILABLE COLORS

 Flint

FLINT
F3120471



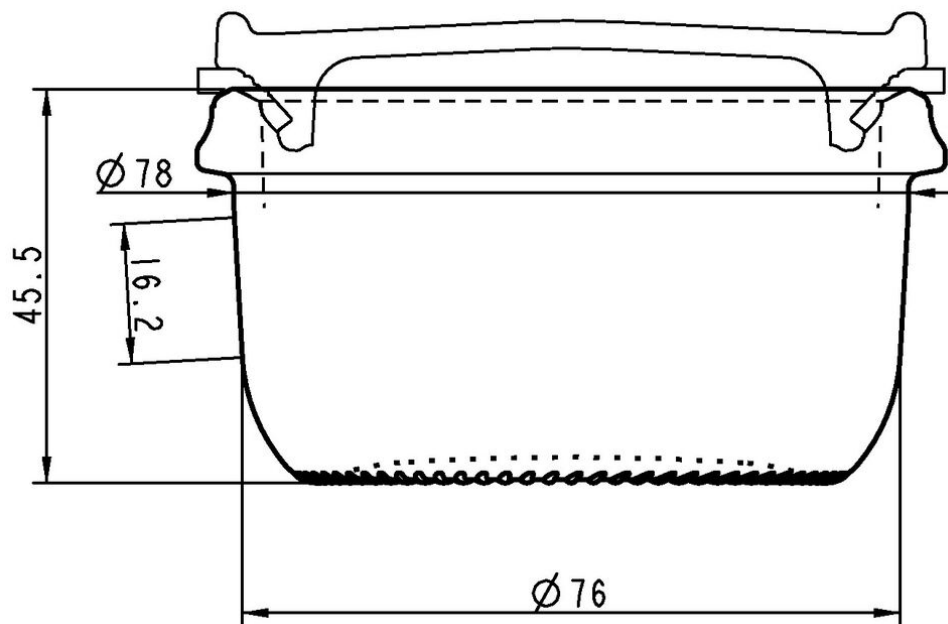

TECHNICAL SPECIFICATIONS

Product code	120471
Capacity	15.5 cl
Brimfull capacity	15.5 cl
Height	45.5 mm
Diameter	78.0 mm
Shape	Round
Finish	Special
Label protection	No
Refillable	No
Weight	125 g
Country	France

PACKAGING SPECIFICATIONS

Containers per pallet	2535
Layers per pallet	15
Pallet width	1000 mm
Pallet depth	1200 mm
Pallet height	1027 mm
Gross weight of pallet	372.00 kg

i Other packaging specs are available upon request.



O-I Europe - 25 May 2026

The images, specifications and other data on this page are for information purposes only. The present information can in no way be used or interpreted as a technical drawing. Specific advice should be obtained from your O-I representative with regards to the suitability of products prior to any application. The information on industry containers is updated from time to time, however O-I reserves the right to amend the specifications or to withdraw certain containers from sale without notice.

www.o-i.com
www.glass-catalog.com

© 2026, O-I Glass, Inc