



FOOD  
COLLECTION



# **PRESERVED FRUITS & VEGETABLES**

From 10cl to a gallon, every fruit and vegetable will find its jar.



# 54CL JAR 310-580 TO82

AVAILABLE COLORS



Flint

FLINT  
F3014264

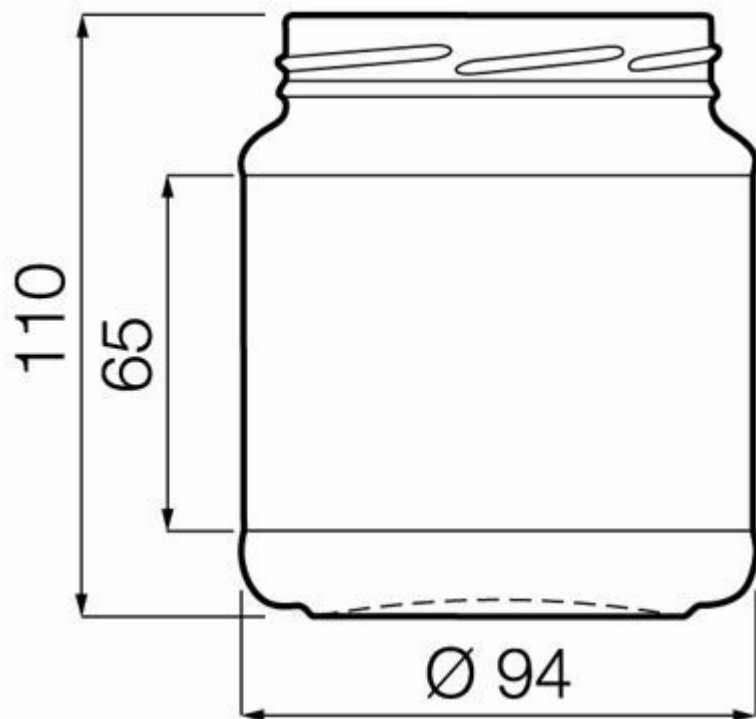

### TECHNICAL SPECIFICATIONS

Product code	014264
Capacity	54.0 cl
Brimfull capacity	58.0 cl
Height	110.0 mm
Diameter	94.0 mm
Shape	Round
Finish	Wide mouth
Label protection	Yes
Refillable	No
Weight	270 g
Country	Estonia

### PACKAGING SPECIFICATIONS

Containers per pallet	2448
Layers per pallet	17
Pallet width	1000 mm
Pallet depth	1200 mm
Pallet height	2060 mm
Gross weight of pallet	718.00 kg

**i** Other packaging specs are available upon request.



O-I Europe - 22 June 2026

The images, specifications and other data on this page are for information purposes only. The present information can in no way be used or interpreted as a technical drawing. Specific advice should be obtained from your O-I representative with regards to the suitability of products prior to any application. The information on industry containers is updated from time to time, however O-I reserves the right to amend the specifications or to withdraw certain containers from sale without notice.

[www.o-i.com](http://www.o-i.com)  
[www.glass-catalog.com](http://www.glass-catalog.com)

© 2026, O-I Glass, Inc